



SUNGLAZE™

Solid Polycarbonate Standing Seam Architectural System



SUNGLAZE™ Solid Polycarbonate Standing Seam Architectural System

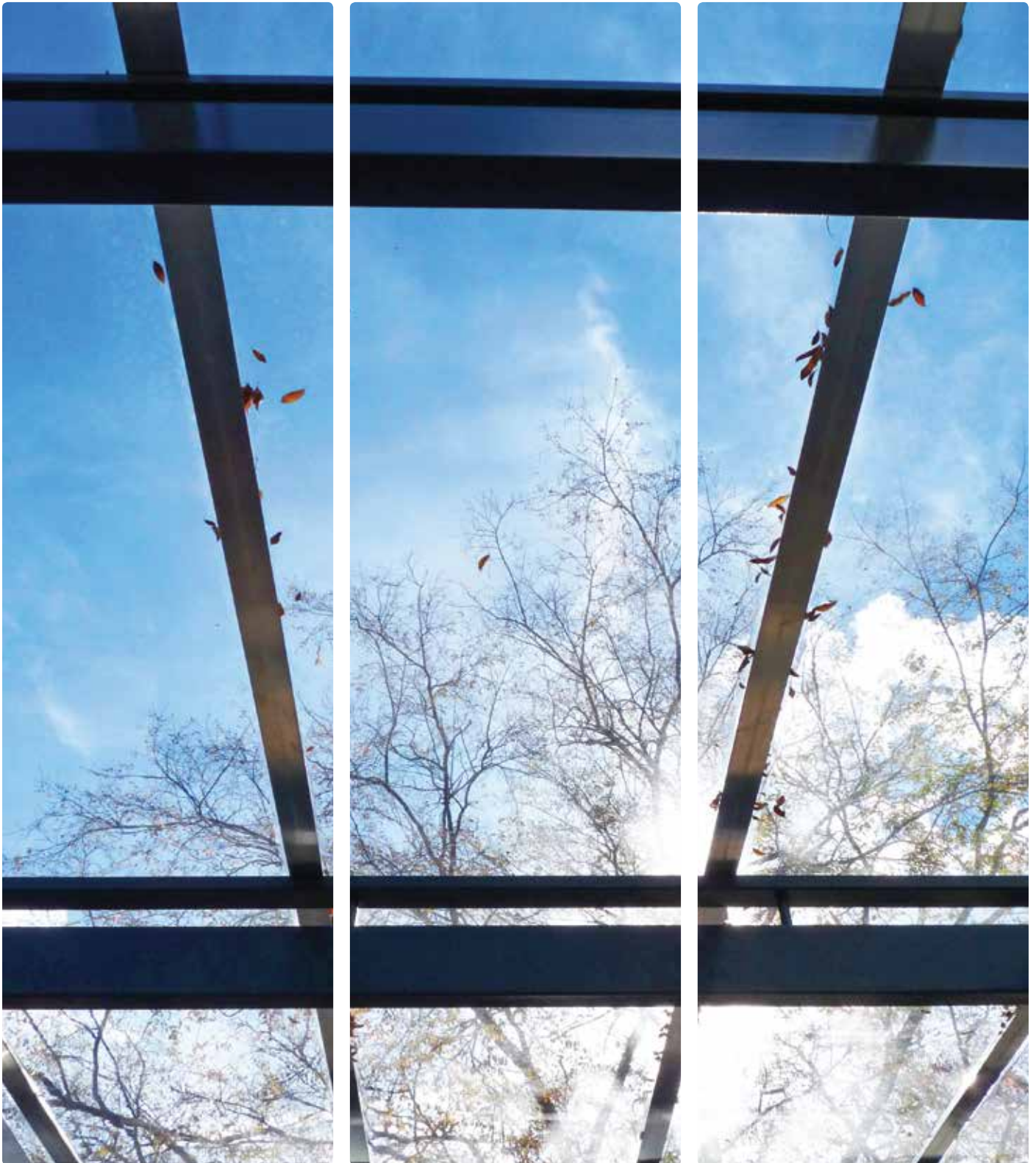

Content

Introduction	2
Main Benefits	2
Applications	2
Panel Types	3
Colours	3
SUNGLAZE™ Projects	4
Thermal Insulation	6
Flammability	6
Typical Physical Properties	7
Acoustic Properties	7
Resistance to UV Radiation	8
Chemical Characteristics	8
System Principles	8
System Components	9
Installation Data	10
Assembly Details	11
Installation Guidelines	12
Manufacturer's Lifetime Warranty	14

Introduction

SUNGLAZE is an architectural system that offers smart design, elegant appearance, versatility, low maintenance and sustainable performance to various architectural challenges. SUNGLAZE incorporates proprietary standing-seam profiling and glazing that enable wide spans and high loading capacity. It can be specified in various lengths to match different structures, including flat and curved designs. SUNGLAZE is easy to fasten; the panels are simply joined by an aluminum profile set that is enclosed at the ends by end-closures. Screws lock the system and fix it to the structure without any penetration through the panels. The Cap-plug completes the assembly, covering the screw head and provides a smooth appearance from above.

Main Benefits

- ✓ Glass-like clear appearance
- ✓ Standing seam leak-proof performance
- ✓ Free thermal expansion
- ✓ Caulking and silicone free
- ✓ Withstanding high loads
- ✓ Easy, fast and safe installation
- ✓ Minimal maintenance

Applications

- Architectural projects
- Commercial and retail
- Sports venues roofing
- Covered walkways
- Open markets
- Service stations
- Entrances
- Pool covers

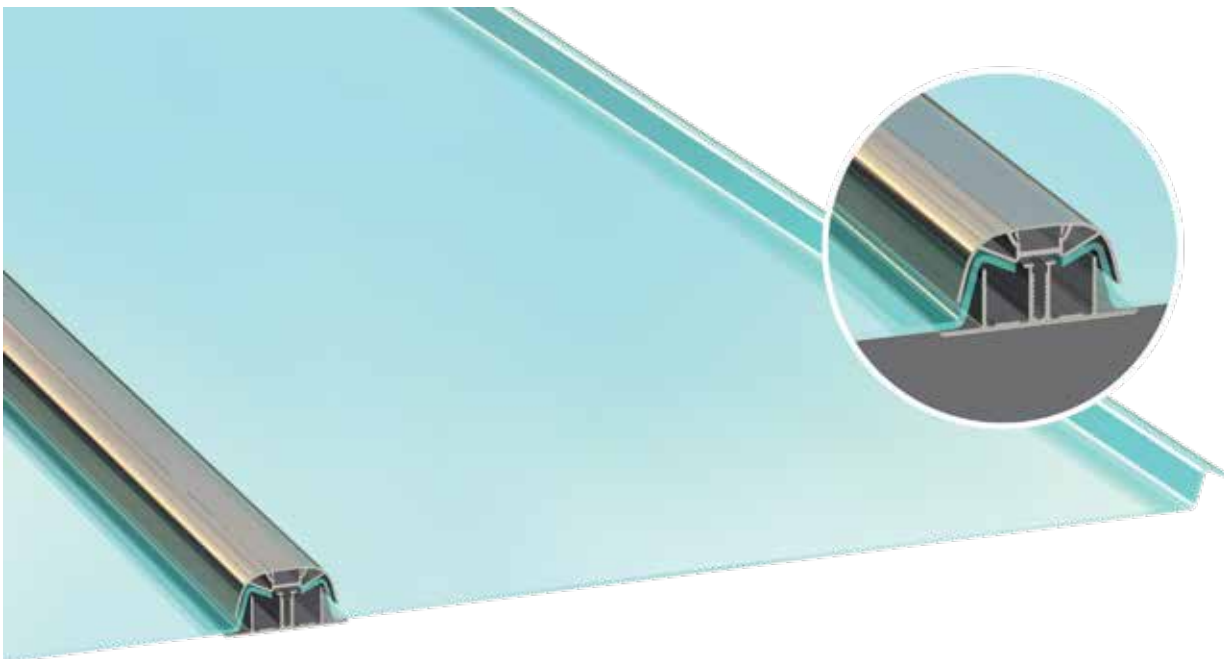

Scan for product
video overview

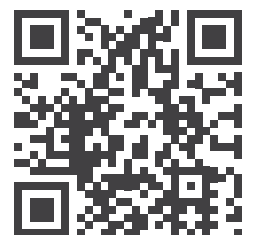

SUNGLAZE™ Projects

Project: Hangzhou Airport, China | Architect: ZIAD | Application: Canopies - 1,900 sqm | SUNGLAZE™ Type: Solar Olympic 4mm



Project: Australian Federal Police, Tullamarine, Australia | Application: Awning | SUNGLAZE™ Type: Clear 4mm

Project: The Lounge Bar, Melbourne, Australia | Application: Canopy | SUNGLAZE™ Type: Clear 4mm



Project: Private home, Point Cook, Australia | Application: Pergola | SUNGLAZE™ Type: Clear 4mm





Thermal Insulation

The attached table compares “U” values of glass and SUNGLAZE panels of equivalent thickness. For any given thickness, the “U” value of SUNGLAZE is lower than that of glass. This can result in a significant 6.5-9% reduction in energy expenditure both for heating in winter and air-conditioning during the summer time. Note that the use of SolarSmart™ panels will partially block heat generating infra-red solar energy, which will further assist in reducing the air-conditioning costs during summer time.

Thickness (mm)	SUNGLAZE™ U Value (W•m²•K)	Glass U Value (W•m²•K)
3	5.43	5.79
4	5.29	5.76

Flammability

All flammability results for SUNGLAZE have been verified through 3rd party accredited testing agencies.

Test	ASTM Standard	Classification
Flammability	AS-1530.3 - 1999	
Self ignition	D-1929	628°C
Smoke density	D-2843	<75%
Burn extent	D-635	CC1
Flame spread / smoke	E-84	Class B

Typical Physical Properties

Property	Method**	Conditions	Units	Value
Mechanical				
Density	D-792		g/cm ³	1.2
Tensile modulus of elasticity	D-638	1 mm/min	Mpa	2,300
Flexural strength	D-790	1 mm/min	Mpa	93
Flexural modulus	D-790	1.3 mm/min	Mpa	2,600
Notched impact strength Izod	D-256	23°C	J/m	800
Impact falling dart	ISO 6603/1d	3mm	J	158
Impact	AS-1562.3			
Charpy Impact after Xenon Arc Exposure (D-6110)	D-2565-08	3000 hrs	% Loss of Impact Strength	<10
Thermal				
HDT (Heat Deflection Temperature)	D-648	Load: 1.82Mpa	°C	135
Vicat softening temperature	D-1525	Load: 1kg	°C	150
Service temperature - Short term			°C	-50 to 120
Service temperature - Long term			°C	-50 to 100
Coefficient of linear thermal expansion	D-696		cm/cm °C	6.5 x 10 ⁻⁵
Thermal conductivity	C-177		W/m °K	0.21
Specific heat capacity	C-351		kJ/kg °K	1.3
Weathering				
Colour change	D-2244	60 months	ΔE	<3
Yellowing index	E-313	60 months	Δ Yellowness Index	<10
Light transmission	D-1003	10 years	%	<6
Leakage / Structural				
Water leakage	E-283	20 psf		none
Air leakage	E-331		cfm/ft ²	0.05
Uniform load	E-330		psf	+140 / -45

*Properties in the table relate to the polycarbonate glazing panels in the SUNGLAZE system.

**ASTM method except where noted otherwise.

Acoustic Properties

Sunglaze panels sound insulation properties are indicated in the table to the right. The attenuation of sound waves together with its impact resistance, has made Sunglaze a material of choice for cladding.

Thickness	Acoustic Insulation DIN 52210-75 RW (db)
4mm	23
3mm	24

Resistance to UV Radiation

Palram polycarbonate panels retain their mechanical properties and transparency throughout a long time of external service due to integrated co-extruded UV protection. The protection will not peel off over time. SUNGLAZE is offered with UV2 version with protection on both sides. The attached graph presents typical results from SUNGLAZE panels tested under accelerated weathering (QUV exposure simulation) that is equivalent to 20 years of actual field exposure. The light transmission of SUNGLAZE was essentially stable.

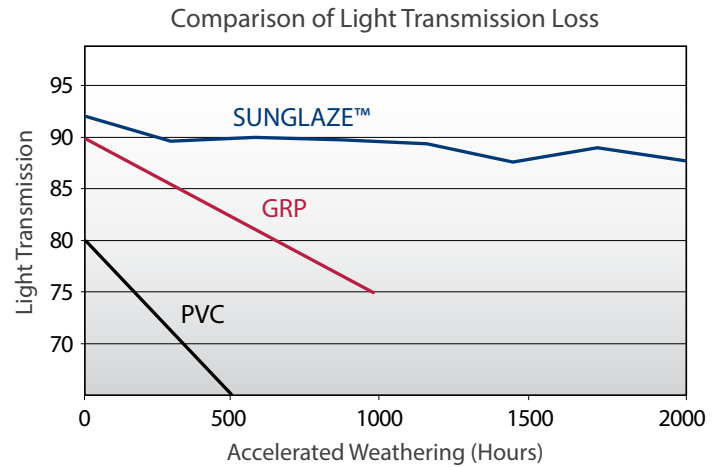

Chemical Characteristics

To obtain a wide listing of Palram’s polycarbonate sheets resistance to chemical agents please visit Palram Australia website at www.palram.com.au or contact your Palram distributor.

System Principles

SUNGLAZE system components fit all panel types, except end closures 07, 08.

Glazing Set



The Base is 65mm wide by 21mm high, anodised extruded aluminium profile. Its maximum length is 7m. The Base is the lower part of the glazing set, placed under the panels and fixed to the structure by the Fixing screws.

The Cover is 53mm wide and 23mm high, anodised extruded aluminium profile. Its maximum length is 7m. The Cover is the upper profile of the glazing assembly, positioned onto the panel edges and Base, and attached to the Base by the Locking screws. The Cap is 19.5mm wide aluminium strip anodised. Its maximum length is 6m. The Cap is clicked into place onto the Cover, concealing the Locking screws from the top, and providing a smooth surface.

Screws



The fixing screw fix the Base to the structure and is a Metal SUPA LOW head 12 x 18 C3 for metal structure. Wafer head 10g x 35 C3 for timber structures.

Mark-2 Base - when fixing cover down use screw TEK 10 x 22mm c3 wafer.

The locking screw is a cross-head tapping screw, 5.5x19mm. These screws attach the Cap onto the Base and panel edges.



4mm End Closure

These are anodised aluminium plates that plug the two ends of the profiles assembly. 4mm End Closure is used for 4/800 panel assembly.

System Components

Component	Part No.	Drawing	Suppliance Data
Base	04		Length: Up to 7m Finish: Anodized
Cover	05		Length: Up to 7m Finish: Anodized
Cap	06		Length: Up to 7m Finish: Anodized
SUNGLAZE 3mm End Closure * Non stocked Item	07		Quantity: each Finish: Anodized
SUNGLAZE 4mm End Closure	08		Quantity: each Finish: Anodized
Fixing Screw Locking screw as per instructions on previous page.	09a		Quantity: 50 Pcs/Box
Fixing Screw Metal SUPA LOW head 12 x 18 C3 for fixing base to metal structure	09b		Quantity: 50 Pcs/Box
Fixing Screw Timber wafer head for fixing base to timber structure 10g x 35 C3	09c		Quantity: 50 Pcs/Box
Locking Screw for end caps Cross-head tapping screw 5.5x19mm (3/4")	10		Quantity: 50 Pcs/Box

Installation Data

Roof structure

SUNGLAZE system is designed for both rafter and purlin construction options, flat or curved. The recommended minimum roof slope for SUNGLAZE applications is 5°. For lower slopes - rafter design is recommended.

Assembled System Width

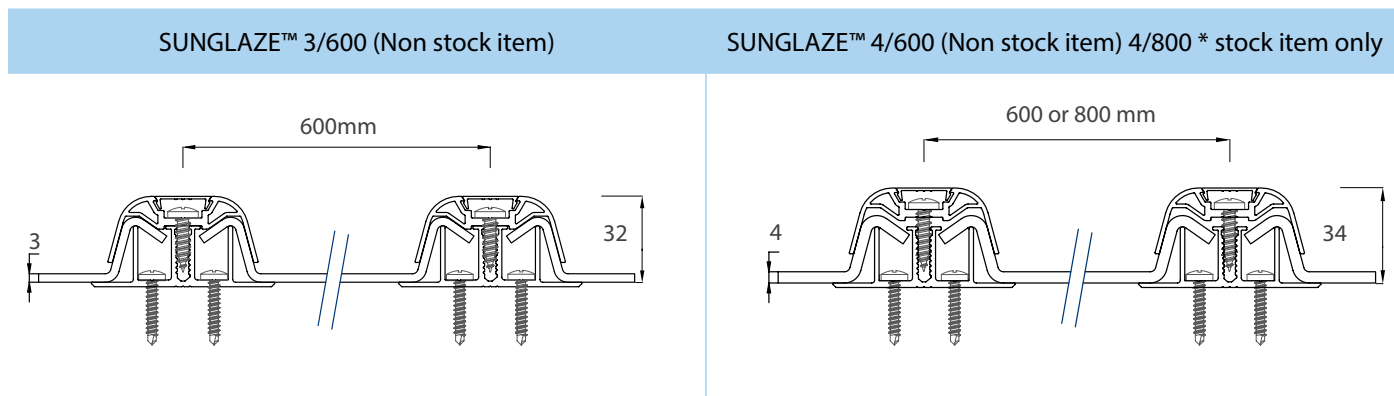

Maximum Spans Between Purlins

Type	Rafter Centers	Single Span (mm)					
		75 kg/m ²	100 kg/m ²	125 kg/m ²	150 kg/m ²	175 kg/m ²	200 kg/m ²
3/600	600	900	820	760	NA	NA	NA
4/600	600	900	820	760	720	680	NA
4/800	800	820	745	690	NA	NA	NA

Type	Rafter Centers	Multi-Span											
		Mid-Span (mm)						End-Span (mm)					
		75 kg/m ²	100 kg/m ²	125 kg/m ²	150 kg/m ²	175 kg/m ²	200 kg/m ²	75 kg/m ²	100 kg/m ²	125 kg/m ²	150 kg/m ²	175 kg/m ²	200 kg/m ²
3/600	600	1540	1400	1300	NA	NA	NA	1210	1100	1020	NA	NA	NA
4/600	600	1540	1400	1300	1220	1160	1110	1210	1100	1020	960	910	870
4/800	800	1400	1275	1180	NA	NA	NA	1100	1000	925	NA	NA	NA

Notes:

1. The values are based on, maximal deflection criterion of L/200 for the aluminium profiles and L/20 for the Polycarbonate panels.
2. The dimensions depicted do not supersede the requirements of local construction codes.
3. In case of installation with supports by rafters, the distance between screws should be 800 mm.

Assembly Details

Please note: All drawings are available as CAD files from www.palram.com.

Wall - Roof detail

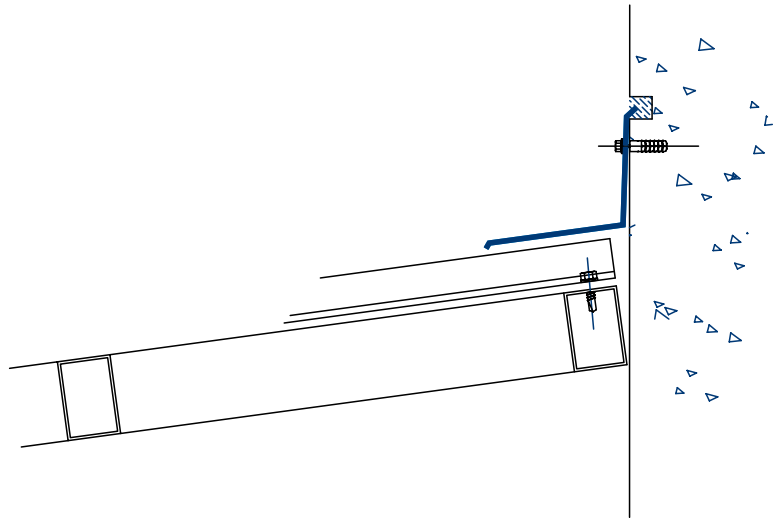

Gutter detail

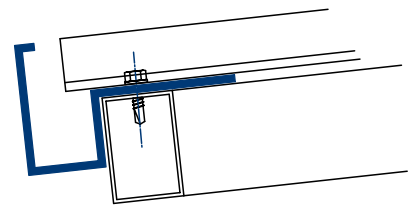

Ridge Cap detail

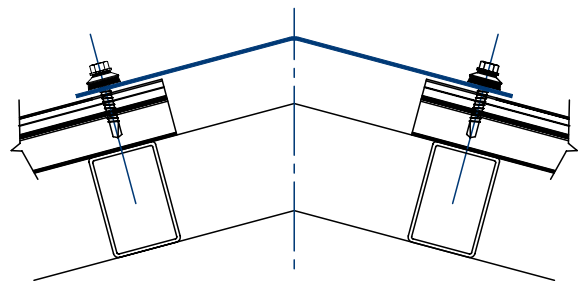

Side flashing

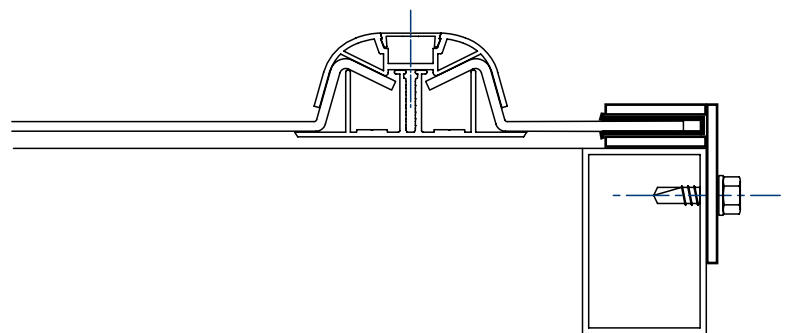

Installation Guidelines

1 Cut to size

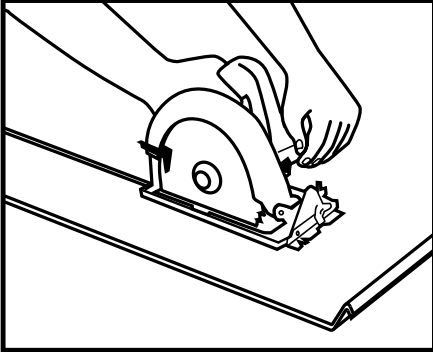

2 Install base

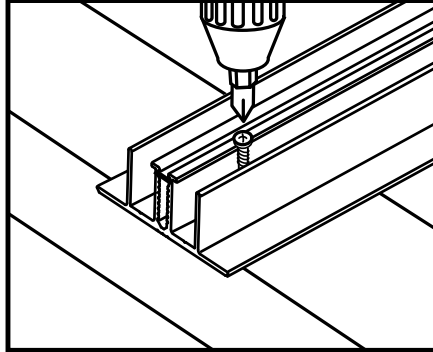

3 Fix next base profile

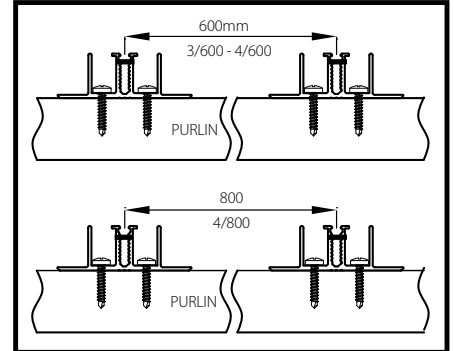

4 Remove inner masking

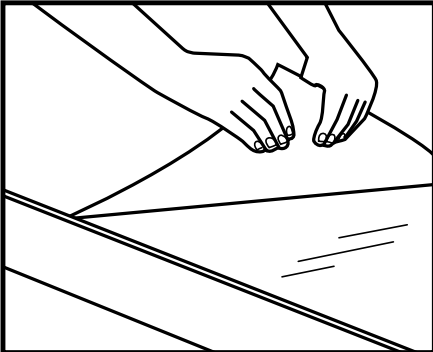

5 Position the panel

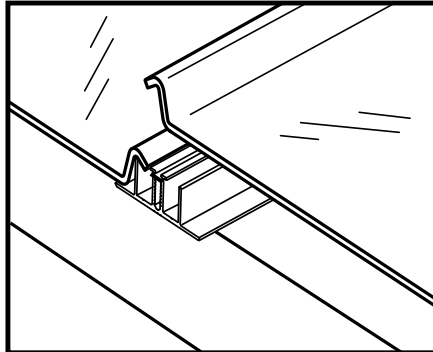

6 Fix Cover

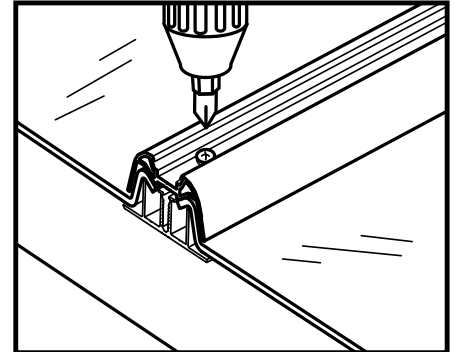

7 Assemble cap

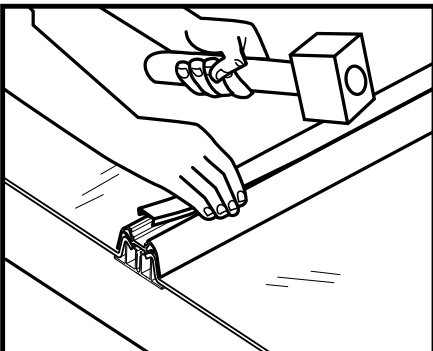

8 Fix End closure

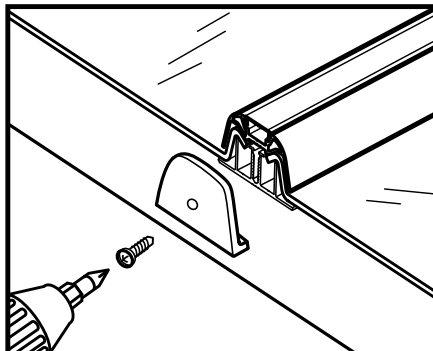

9 Remove outer masking

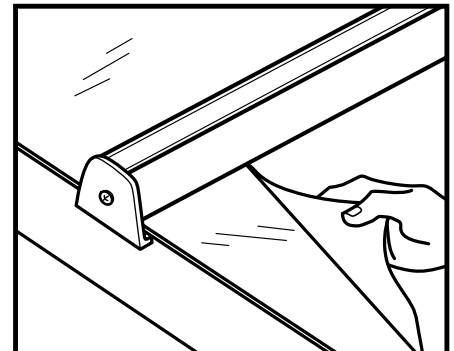

1. Cut to size (Fig. 1)

Cut Alu-profiles to length, allowing for overhangs of up to 100mm at each end. An overhang of minimum 50mm over the end-purlin into the gutter is recommended. Cut panels to length, 20mm shorter than Alu-profiles for expansion allowance. Use a circular saw or hand saw with fine tooth blades and moderate feeding rate for easier and finer cutting.

2. Install base profile (Fig. 2)

Set the first base profile at the precise center line of the supporting structure, and install base it to the structure using the provided fixing screws.

Purlin: Fix screw at each purlin base junction on both sides of base (two screws for every junction).

Rafter: Screws centers should be 450mm center and alternating sides.

Curved: Locate the fixing screws on both sides of base - two screws for every junction between base and purlin.

Note: In high wind areas and cyclonic regions fixing screws need to be both sides of base to structure. This is also recommended for flat applications .

3. Fix next base profile (Fig. 3)

Locate center line of next base profile at 600mm (for 3/600 and 4/600) or 800mm (for 4/800) from prior base center line, and fix it as describe in step 2.

IMPORTANT! measure and mark the Base center line at every purlin, or at every screw location on a rafter. It is highly advisable to prepare and use a spacer rod. (Note: in order to avoid piling up of deviations, do not fix more than 1-2 base profiles ahead of actual assembly).

4. Remove inner masking (Fig. 4)

Remove the protective masking from the panel back surface (the face to contact the purlins). Keep this side away from the roof purlins until final positioning of the panel, to avoid scratching.

5. Position panels (Fig. 5)

Position the panels onto the bases. Make sure the panels are correctly seated along their whole length.

6. Fix Cover (Fig. 6)

Position Cover onto the base and panels edges. Pre-drill 5mm holes along the positioning groove every 250mm, it is recommended to safely perform pre-drilling in advance on the ground). Fix the Cover with locking screws through the pre-drilled holes and into to the base profile. The screws on both ends of the cover should be located 50mm from each profile end.

7. Assemble Cap (Fig. 7)

Click Cap into place on top of the Cover using a rubber mallet, performing moderate strikes with short intervals.

8. Fix end closure (Fig. 8)

Fix End Closure at the bottom end of the Alu profiles (gutter end).

9. Remove outer masking (Fig. 9)

Remove the protective masking from the panel's external face shortly after installation. Delaying removal of the masking can make it very difficult to remove later. (Note: on hot days remove top protective film immediately after installation to prevent film from bonding to the panel!)

10. Repeat stages 3 to 9.

11. Cut side panels to size

Determine width of the required side panels and cut to size. Use a circular saw or hand saw with fine tooth blades with moderate feeding rate for easier and finer cutting.

12. Side fixing for cut sheet (side flashing)

F - section to be used with channel gasket as per details.

Notes:

1. SUNGLAZE system does not require using silicones or adhesives for parts interface. For sealing of flashing assemblies use only Palram approved accessories, silicones, sealing tape, closure fixtures etc.

2. To clean SUNGLAZE panels, use a pressure washer with a fanned spray nozzle and allow natural drying. Do not use cloth, sponge, chamois or similar accessories. Doing this might scratch the panels and harm their appearance.

Manufacturer's Lifetime Warranty

SUNGLAZE panels are guaranteed for water leak-proof performance for 25 years. SUNGLAZE panels bear a limited lifetime warranty not to lose more than 6% of light transmission for 10 years and no more than 1% per year thereafter, when measured according to ASTM D1003-77. SUNGLAZE panels are warranted for up to 10 years from the date of purchase not to break or fail as a result of impact by hail measuring up to 20mm in diameter, in speed of up to 21m/s.

Please note: Warranties only apply to installations and maintenance that follow Palram installation instructions and specifications.

02/2015 The data in this publication supersedes previous releases. For the latest update refer to our website: www.palram.com.au

All marketing materials and any content therewith provided by Palram® are provided solely for the purpose of supporting and enhancing the marketing of Palram® products. These materials are protected by Palram's intellectual property rights and may not be used for any other purpose or in connection with the sale of products of any other manufacturer. These materials may not be transferred to or used by any third party without prior permission of Palram.



PALRAM SA/NT
517A Cross keys Road
Cavan SA 5094
Tel: (08) 8262 2288
Fax: (08) 8262 3388
salesa@palram.com

PALRAM NSW/ACT
Unit 2/26 Redfern Street
Wetherill Park NSW 2164
Tel: (02) 8788 6100
Fax: (02) 8788 6199
salesnsw@palram.com

PALRAM QLD
Unit 9C / 380 Bilsen Road
Geebung QLD 4034
Tel: (07) 3172 5581
Fax: (07) 3172 5516
salesqld@palram.com

PALRAM VIC/TAS
34 Buys Court
Derrimut VIC 3030
Tel: (03) 9219 4444
Fax: (03) 9219 4455
salesvic@palram.com

PALRAM WA
74 Christable Way
Landsdale WA 6065
Tel: (08) 9302 4173
Fax: (08) 9302 5287
saleswa@palram.com



10.2017

In as much as Palram Industries has no control over the use to which others may put the material, it does not guarantee that the same results as those described herein will be obtained. Each user of the material should make his own tests to determine the material's suitability for his own particular use. Statements concerning possible or suggested uses of the materials described herein are not to be construed as constituting a license under any Palram Industries patent covering such use or as recommendations for use of such materials in the infringement of any patent. Palram Industries or its distributors cannot be held responsible for any losses incurred through incorrect installation of the material. In accordance with our company policy of continual product development you are advised to check with your local Palram Industries supplier to ensure that you have obtained the most up to date information.

©2008 Palram Industries Ltd. | SUNGLAZE is trademark of Palram Industries Ltd.



www.palram.com.au